

# ORMIG 40 IE

## INDUSTRIEMOBILKRAN

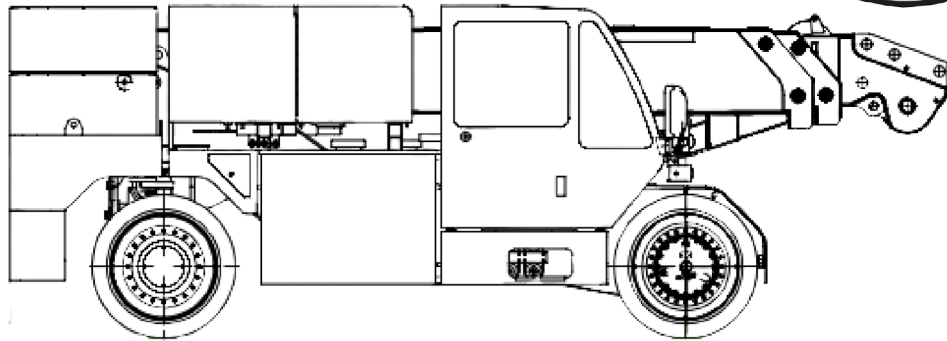

### KURZÜBERSICHT

13,00m HUBHÖHE  
MAX. TRAGFÄHIGKEIT: 40000 kg

### TECHNISCHE DATEN

ANTRIEBSART	ELEKTRO
MAX. TRAGFÄHIGKEIT	40000 kg
TRANSPORTABMESSUNGEN (LXBXH)	6,86 m x 2,20 m x 2,39 m
AUSLEGER	8,50 m
GESAMTGEWICHT	21000 kg
MASCHINE SAMT GEGENGEWICHTE	ca. 31800 kg
BESONDERHEITEN	Weißer Reifen, Elektronische Steuerung, die die Lenkung an der Kranachse ermöglicht



# Gräber

Arbeitsbühnen · Stapler · Krane

WWW.GRAEBER.RENTALS

# ORMIG 40 IE

## INDUSTRIEMOBILKRAN



TRAGLAST 0 KONTERGEWICHT (NUR GRUNDPLATTE)

20200 kg

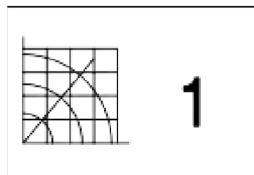
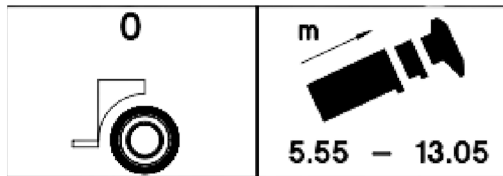

DIN

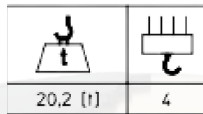

20.2 (t)

4

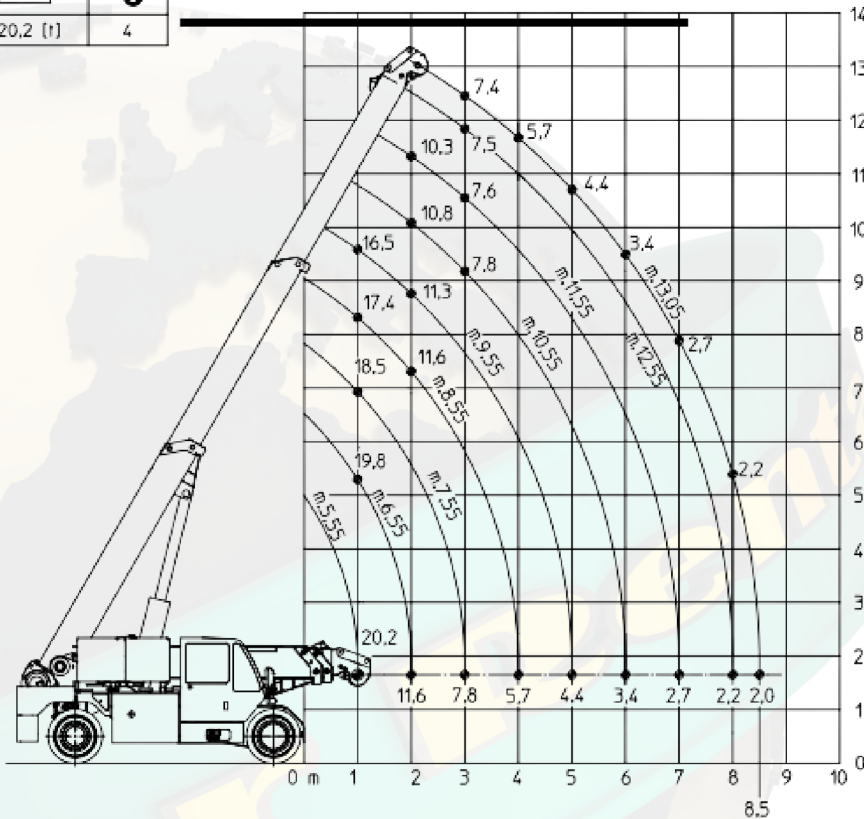

# Gräber

Arbeitsbühnen · Stapler · Krane

WWW.GRAEBER.RENTALS

# ORMIG 40 IE

## INDUSTRIEMOBILKRAN





TRAGLAST 1 KONTERGEWICHT

26000 kg

0+1	m  5.55 – 13.05
-----	--

 2	DIN
---	-----

	
26.0-21.6 [t]	6
21.6 [t]	4

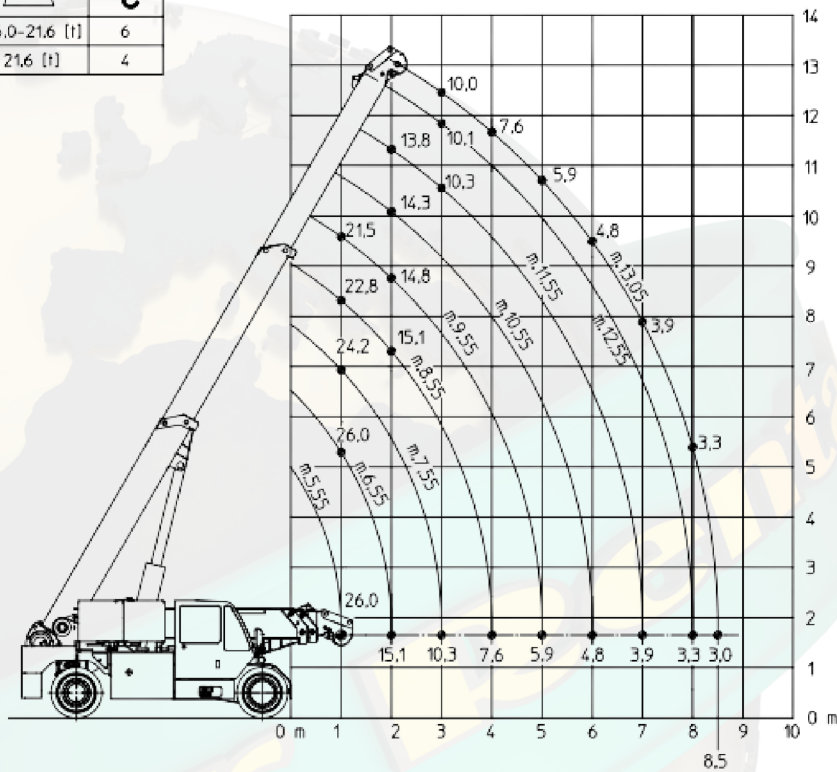

# Gräber

Arbeitsbühnen · Stapler · Krane

WWW.GRAEBER.RENTALS

# ORMIG 40 IE

## INDUSTRIEMOBILKRAN



TRAGLAST 2 KONTERGEWICHT

34000 kg

0+1+2



m



5.55 – 13.05

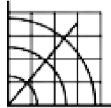

3

DIN



40-32,4 [t]	8
32,4-21,6 [t]	6
21,6 [t]	4

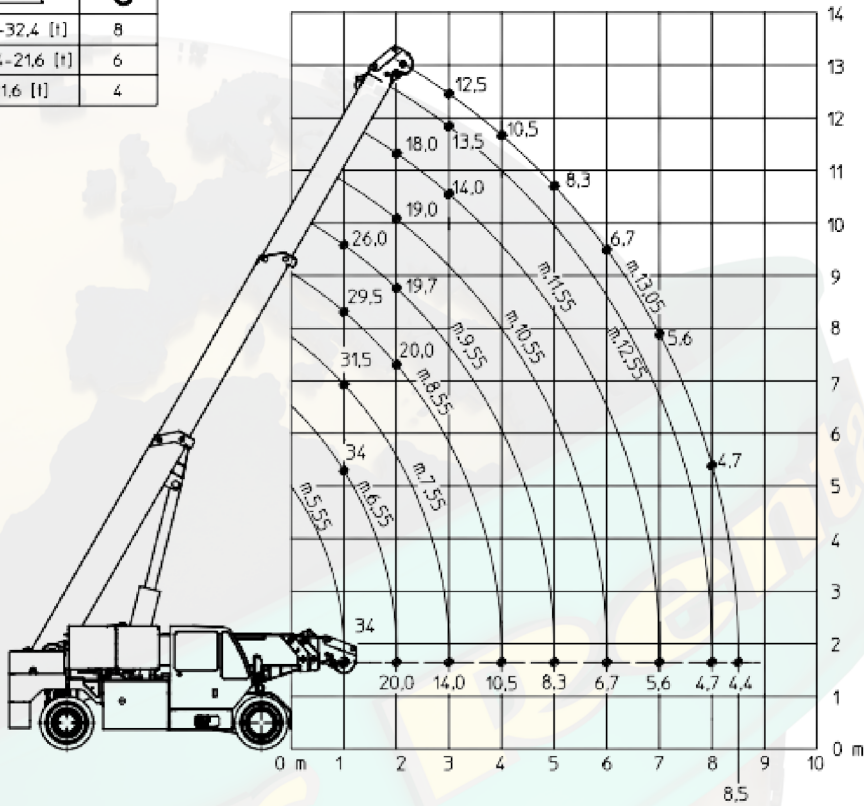

# Gräber

Arbeitsbühnen · Stapler · Krane

WWW.GRAEBER.RENTALS

# ORMIG 40 IE

## INDUSTRIEMOBILKRAN



TRAGLAST 3 KONTERGEWICHTE (VOLLER BALLAST)

40000 kg

0+1+2+3

m

5.55 – 13.05

4

DIN

40-32,4 [t]	8
32,4-21,6 [t]	6
21,6 [t]	4

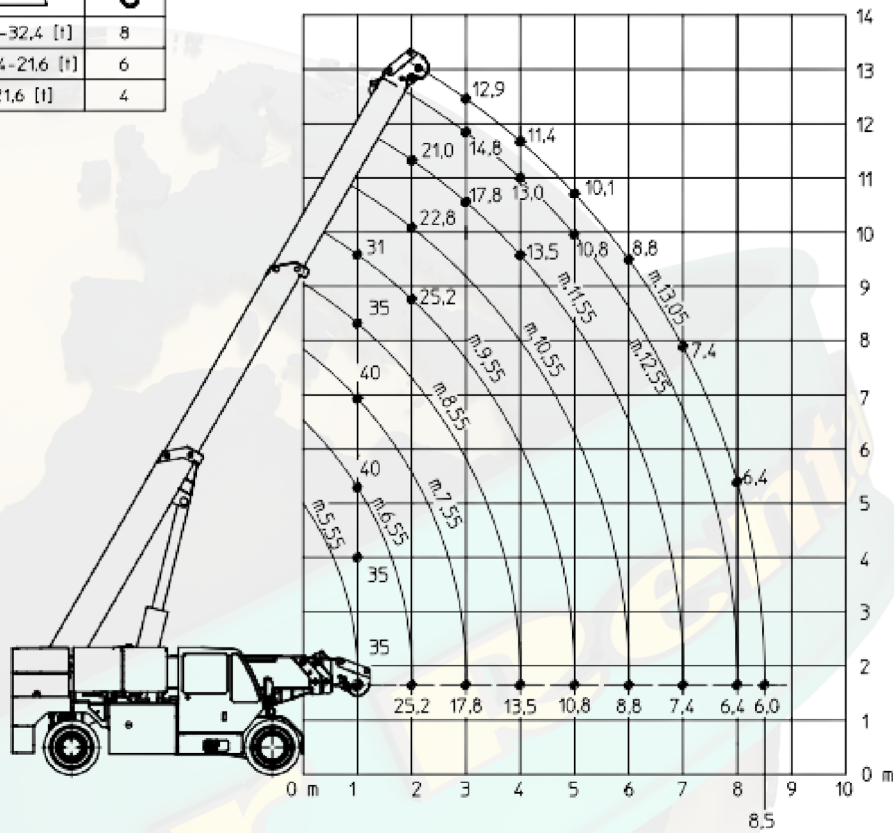

# Gräber

Arbeitsbühnen · Stapler · Krane

WWW.GRAEBER.RENTALS

# ORMIG 40 IE

## INDUSTRIEMOBILKRAN



TRAGLAST HYDR.JIB 2,65M - (0 KONTERGEW.-OHNE BALLAST)	6400 kg
---	---------

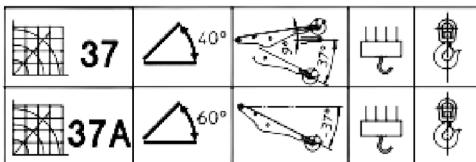
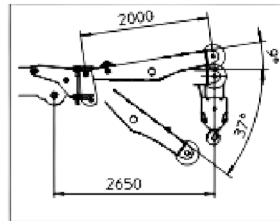
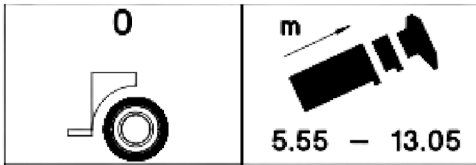

DIN

6.4-5.0 [t]	2
5.0 [t]	1

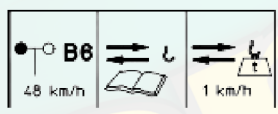
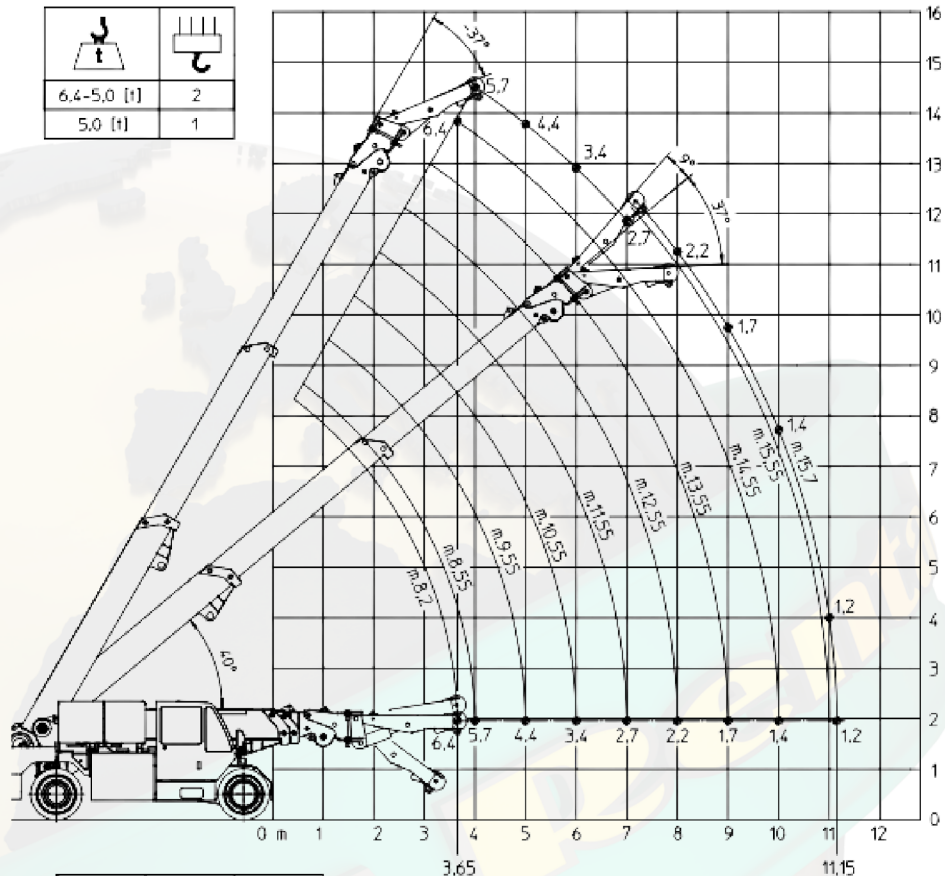

# Gräber

Arbeitsbühnen · Stapler · Krane  
WWW.GRAEBER.RENTALS

# ORMIG 40 IE

## INDUSTRIEMOBILKRAN



TRAGLAST HYDR.JIB 2,65M - (1 KONTERGEW.)

8500 kg

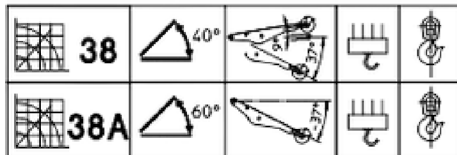
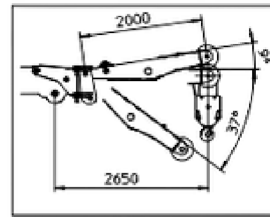
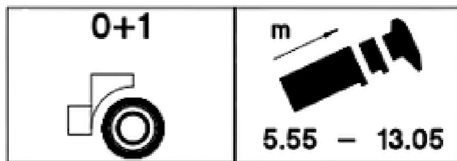

DIN

8.5-5.0 [t]	2
5.0 [t]	1

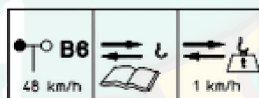
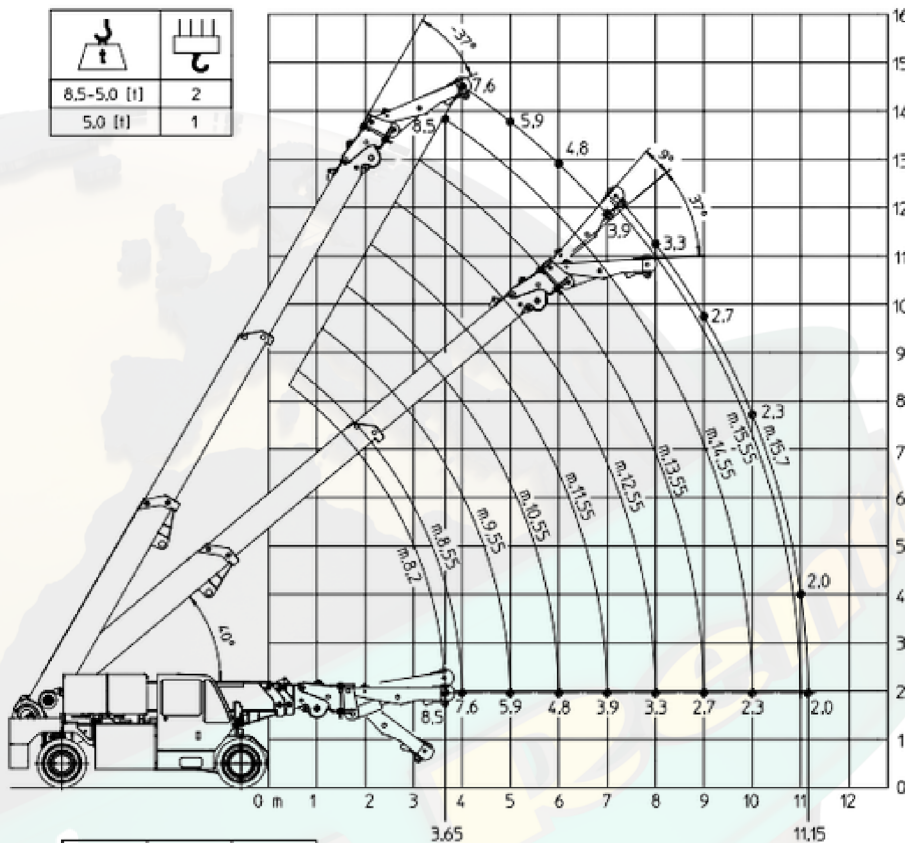

# Gräber

Arbeitsbühnen · Stapler · Krane

WWW.GRAEBER.RENTALS

# ORMIG 40 IE

## INDUSTRIEMOBILKRAN



TRAGLAST HYDRAULISCHER JIB 2,65M - (2 KONTERGEWICHTE) 10000 kg

0+1+2	m 5.55 - 13.05

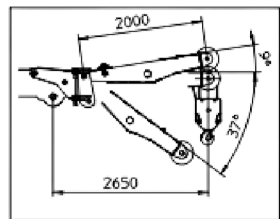

DIN

10.0-5.0 (t)	2
5.0 (t)	1

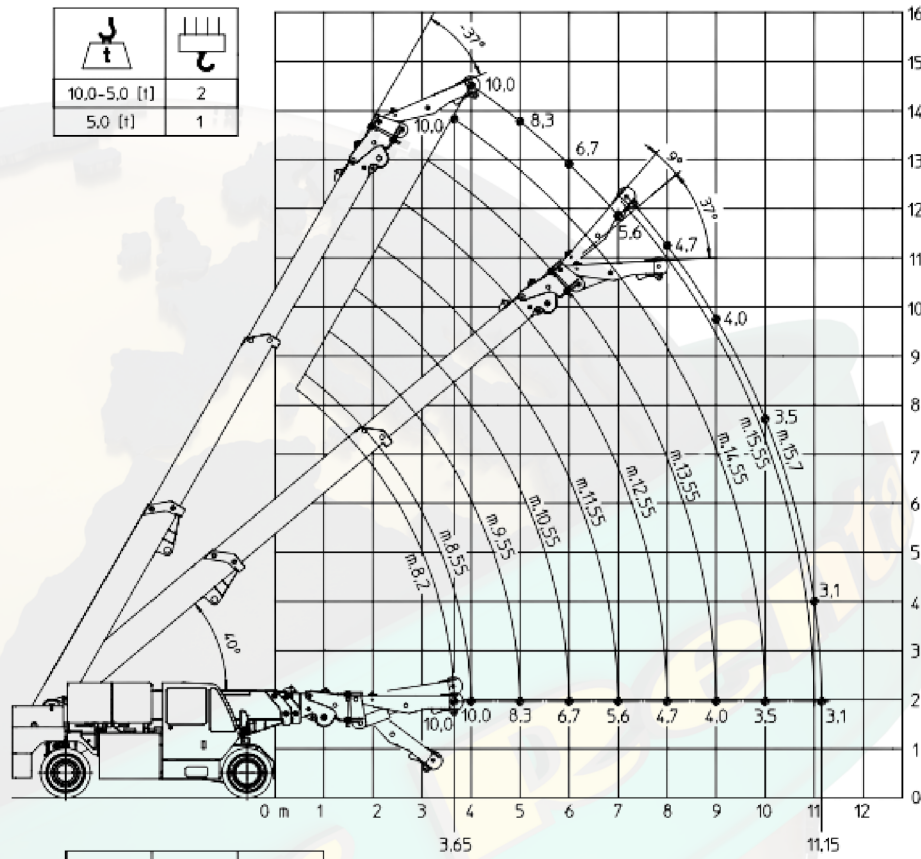

48 km/h	1 km/h	1 km/h



# Gräber

Arbeitsbühnen · Stapler · Krane  
WWW.GRAEBER.RENTALS



# ORMIG 40 IE

## INDUSTRIEMOBILKRAN



TRAGLAST HYDR.JIB 2,65M - (3 KONTERGEWICHTE - VOLLER BALLAST)

10000 kg

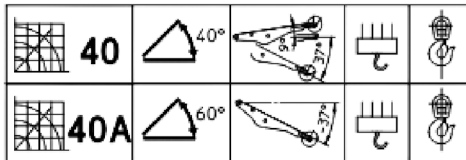
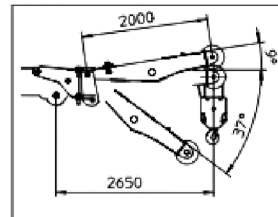
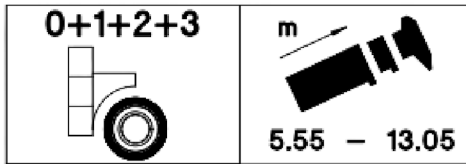

DIN

10.0-5.0 [i]	2
5.0 [i]	1

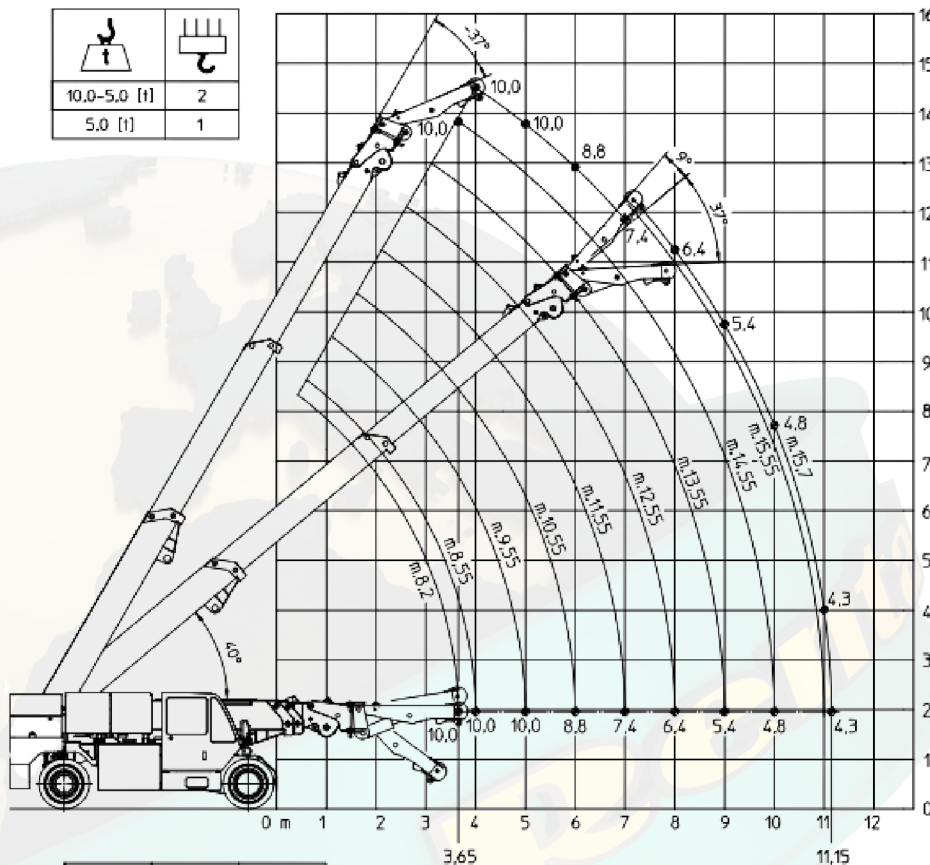

48 km/h	2 km/h	1 km/h



# Gräber

Arbeitsbühnen · Stapler · Krane

WWW.GRAEBER.RENTALS

# ORMIG 40 IE

## INDUSTRIEMOBILKRAN



TRAGLAST HYDR.JIB 4,15M(MIT VERL.) - (0 KONTERGEW.-OHNE BALLAST)

4400 kg

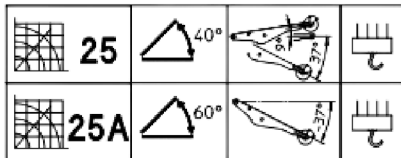
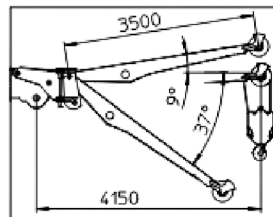
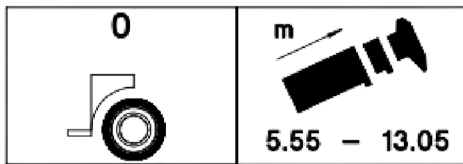

DIN

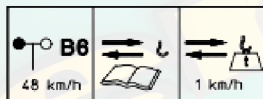
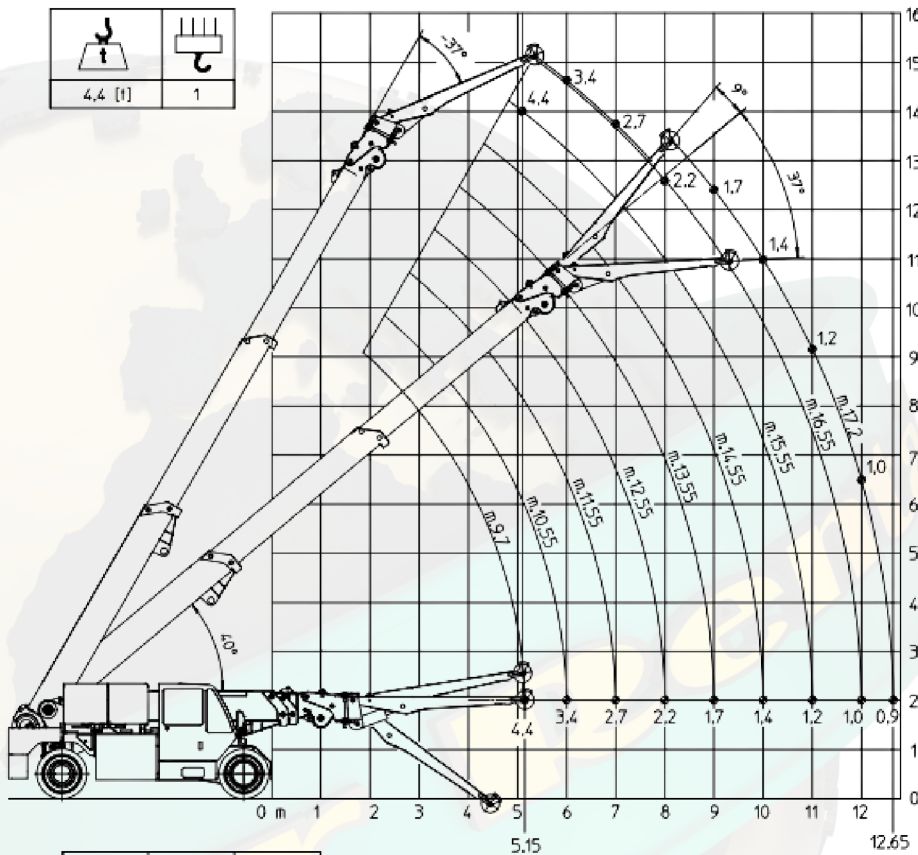
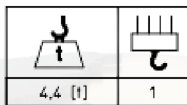

# Gräber

Arbeitsbühnen · Stapler · Krane

WWW.GRAEBER.RENTALS

# ORMIG 40 IE

## INDUSTRIEMOBILKRAN



TRAGLAST HYDR.JIB 4,15M(MIT VERL.) - (1 KONTERGEWICHT)

5900 kg

0+1	m
	5.55 - 13.05

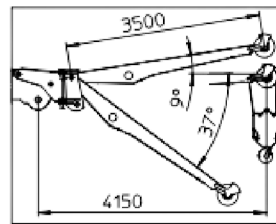

	26			
	26A			

DIN

5.9-5.0 (t)	2
5.0 (t)	1

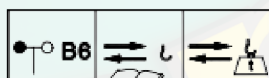
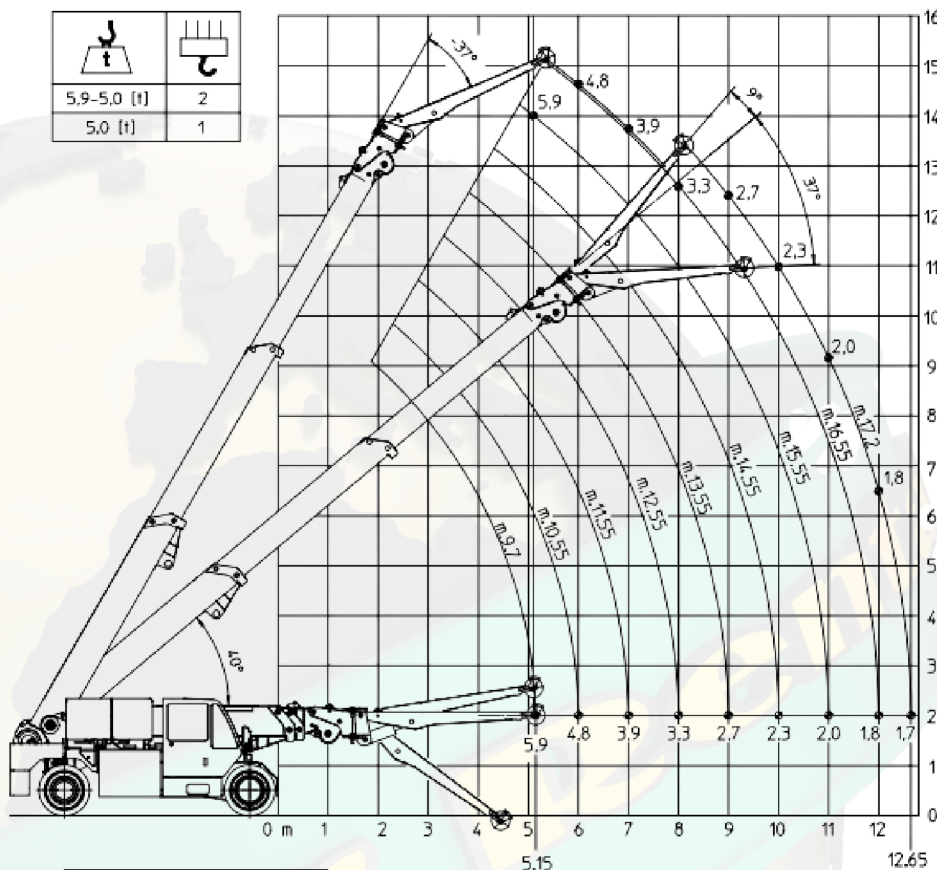

# Gräber

Arbeitsbühnen · Stapler · Krane

WWW.GRAEBER.RENTALS

# ORMIG 40 IE

## INDUSTRIEMOBILKRAN



TRAGLAST HYDR.JIB 4,15M(MIT VERL.) - (2 KONTERGEWICHTE)

7000 kg

0+1+2	m
	5.55 - 13.05

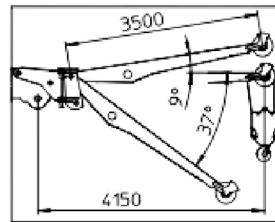

	27			
	27A			

DIN

7.0-5.0 (t)	2
5.0 (t)	1

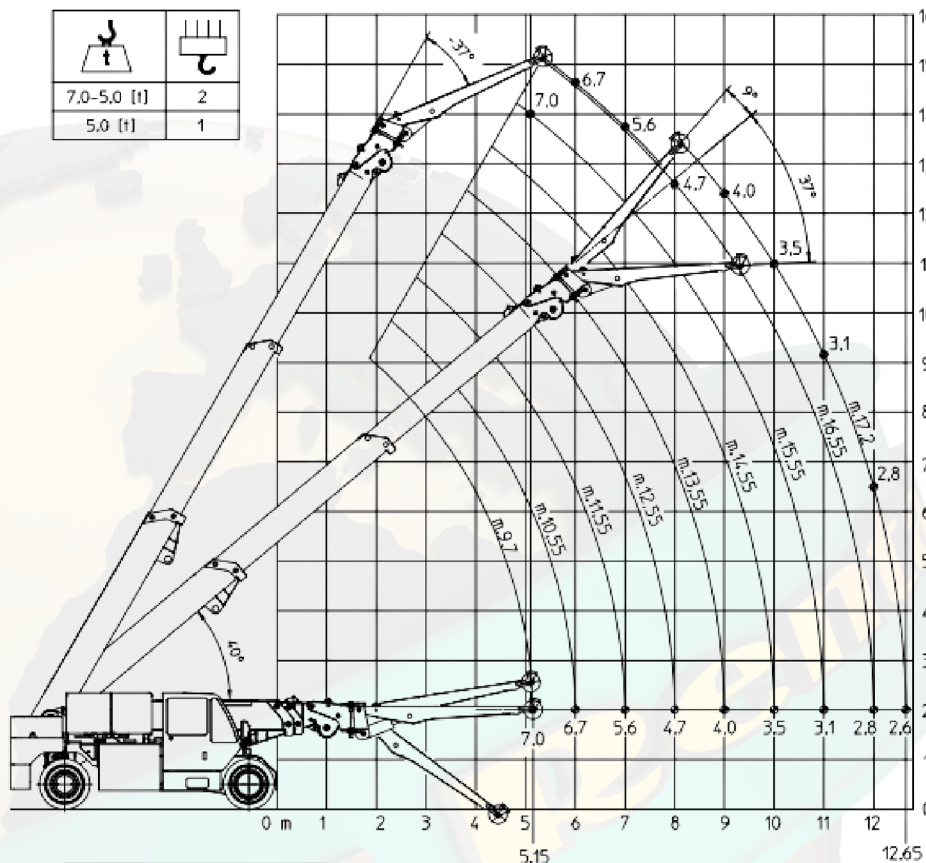

48 km/h		1 km/h



# Gräber

Arbeitsbühnen · Stapler · Krane

WWW.GRAEBER.RENTALS

# ORMIG 40 IE

## INDUSTRIEMOBILKRAN



**TRAGLAST HYDR.JIB 4,15M(MIT VERLÄNGERUNG)  
(3 KONTERGEWICHTE - VOLLER BALLAST)**

**7000 kg**

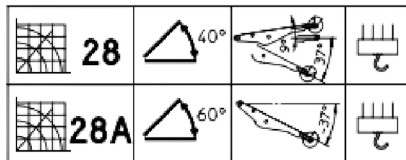
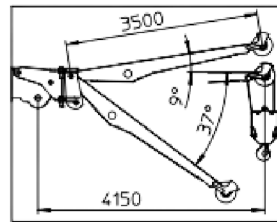
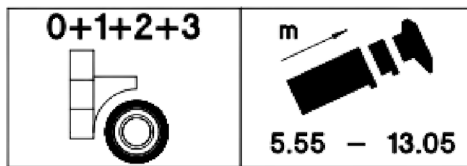

**DIN**

7,0-5,0 [t]	2
5,0 [t]	1

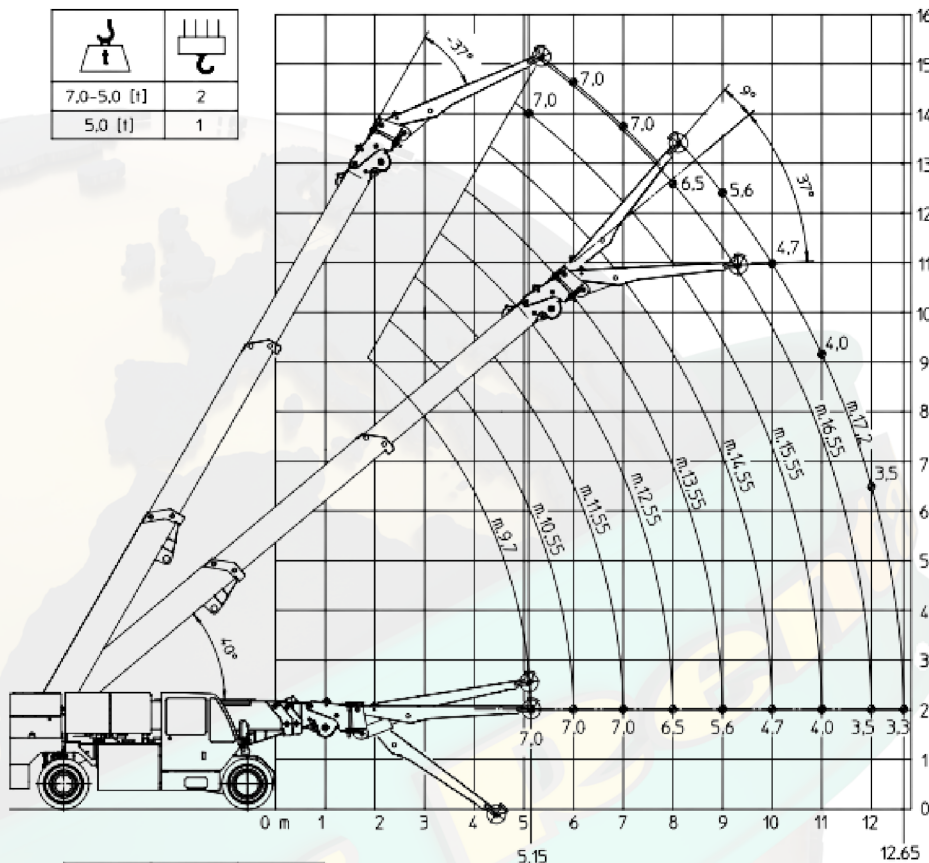

	48 km/h	2 km/h	1 km/h



# Gräber

Arbeitsbühnen · Stapler · Krane

[WWW.GRAEBER.RENTALS](http://WWW.GRAEBER.RENTALS)

# ORMIG 40 IE

## INDUSTRIEMOBILKRAN



TRAGLAST MAN.JIB 0,9M - (0 KONTERGEW.-OHNE BALLAST)

11600 kg

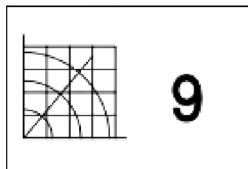
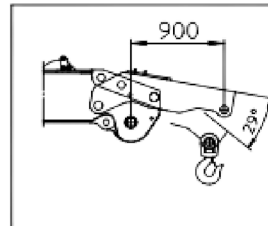
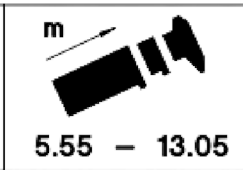
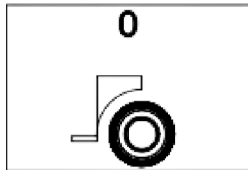

DIN

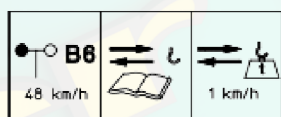
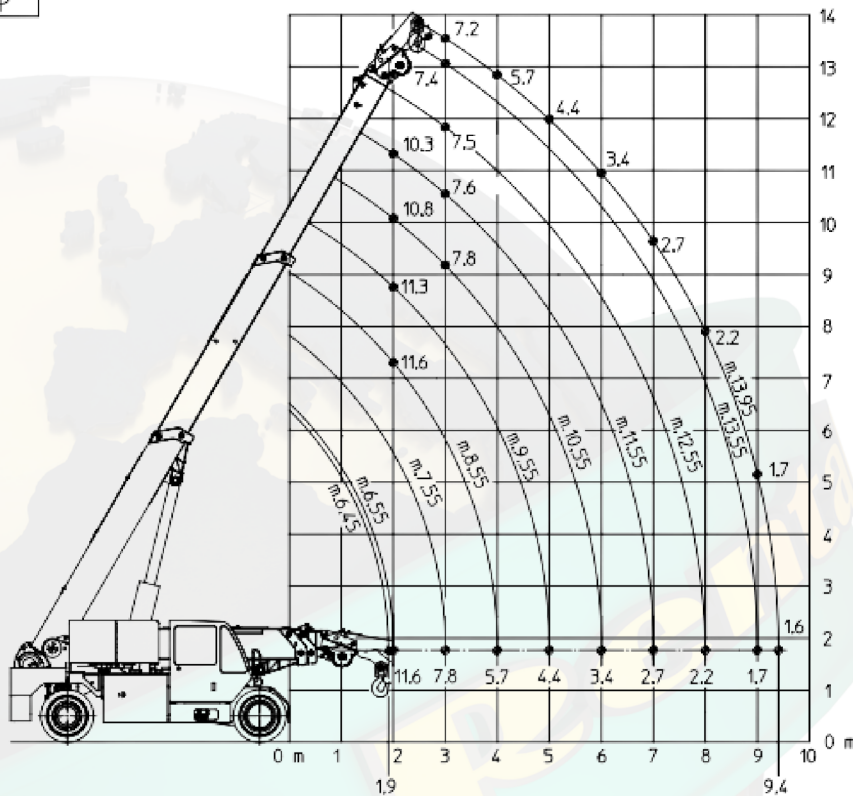

# Gräber

Arbeitsbühnen · Stapler · Krane

WWW.GRAEBER.RENTALS

# ORMIG 40 IE

## INDUSTRIEMOBILKRAN



TRAGLAST MAN.JIB 0,9M - (1 KONTERGEW.)

15100 kg

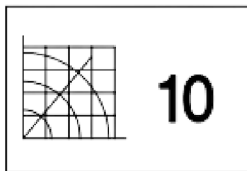
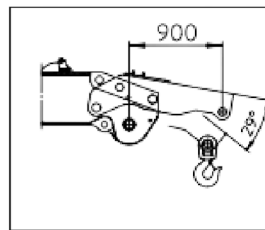
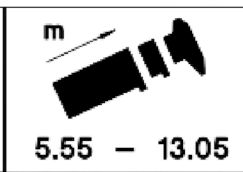
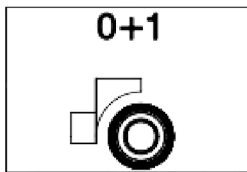

DIN

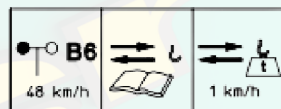
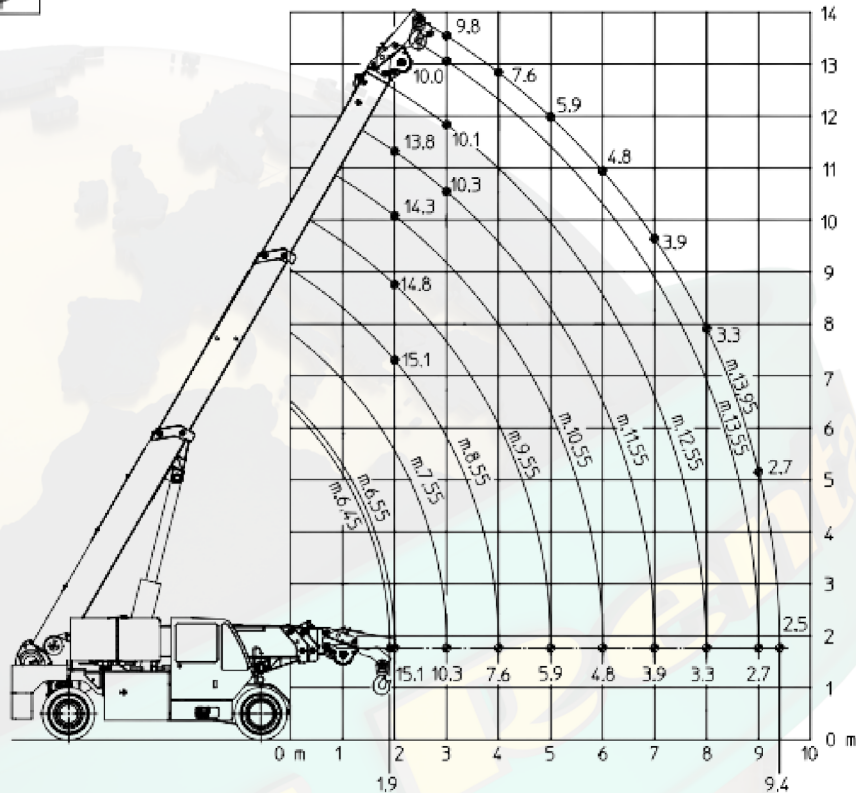

# Gräber

Arbeitsbühnen · Stapler · Krane

WWW.GRAEBER.RENTALS

# ORMIG 40 IE

## INDUSTRIEMOBILKRAN



TRAGLAST MAN.JIB 0,9M - (2 KONTERGEW.)

20000 kg

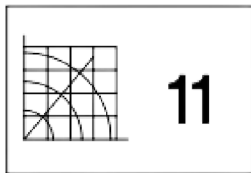
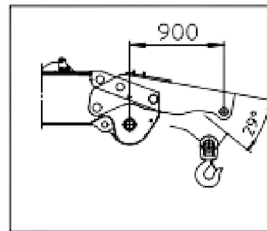
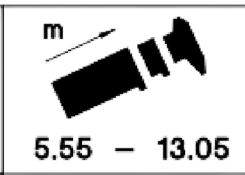
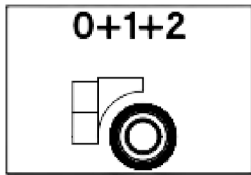

DIN

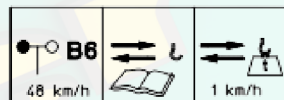
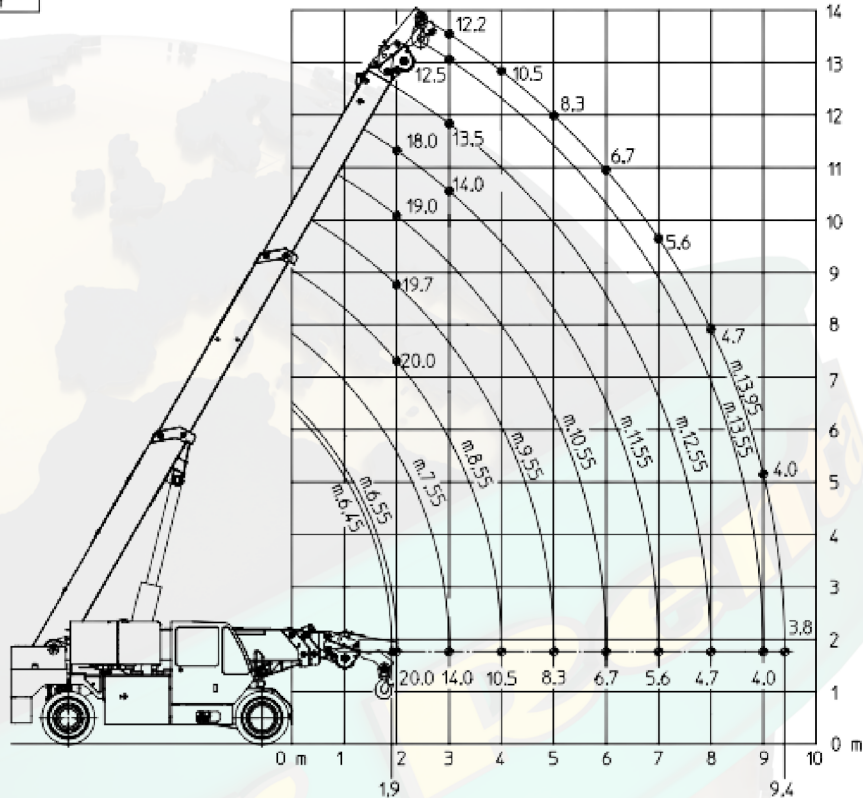

# Gräber

Arbeitsbühnen · Stapler · Krane

WWW.GRAEBER.RENTALS



# ORMIG 40 IE

## INDUSTRIEMOBILKRAN



TRAGLAST MAN.JIB 0,9M - (3 KONTERGEW.-VOLLER BALLAST)

25000

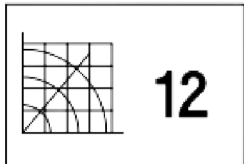
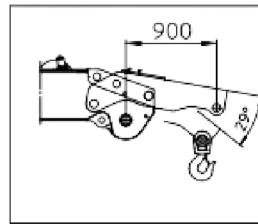
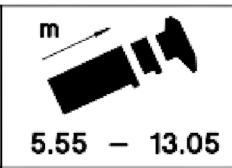
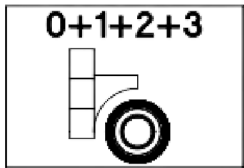

DIN

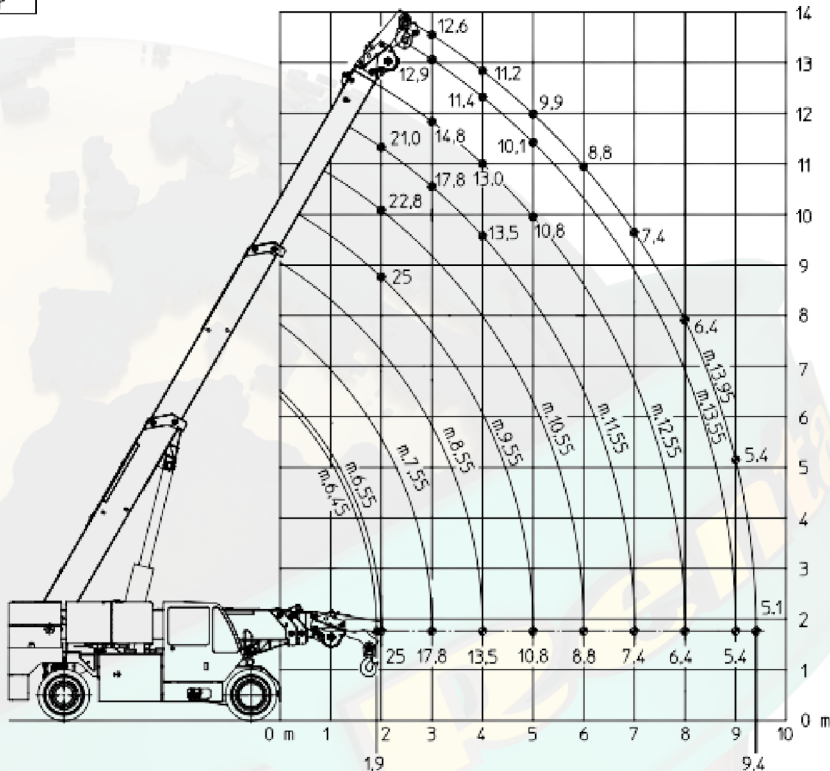

# Gräber

Arbeitsbühnen · Stapler · Krane

WWW.GRAEBER.RENTALS

# ORMIG 40 IE

## INDUSTRIEMOBILKRAN



TRAGLAST MAN.JIB 2,08M (MIT VERL.) - (0 KONTERGEW.-OHNE BALLAST)

7800 kg

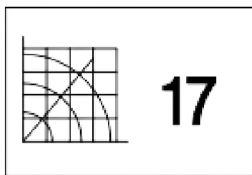
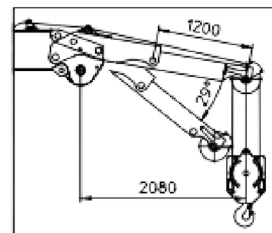
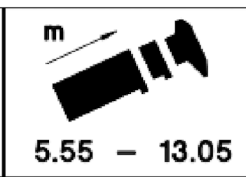
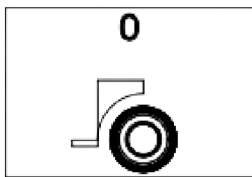

DIN

7,8-5,0 [t]	2	
5,0 [t]	1	

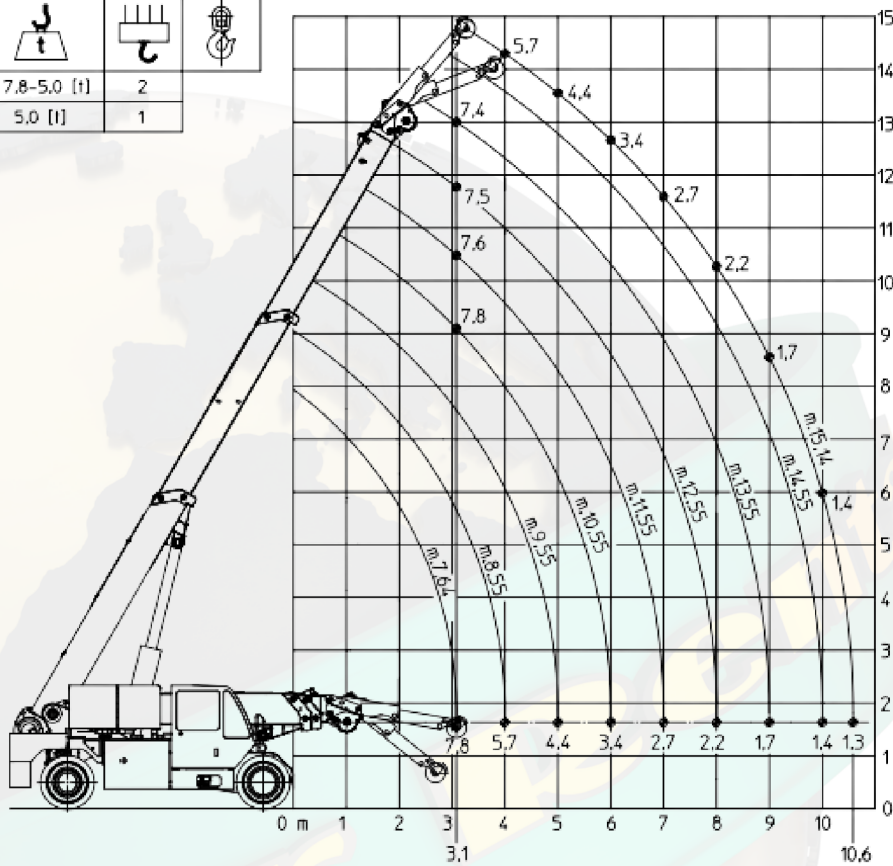

B6	48 km/h	1 km/h



# Gräber

Arbeitsbühnen · Stapler · Krane

WWW.GRAEBER.RENTALS

# ORMIG 40 IE

## INDUSTRIEMOBILKRAN



TRAGLAST MAN.JIB 2,08M (MIT VERL.) - (1 KONTERGEW.)

10300 kg

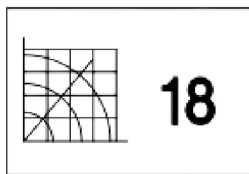
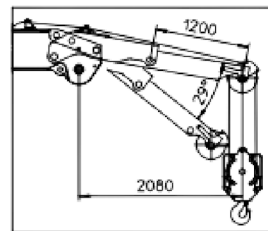
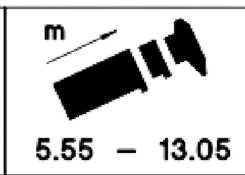
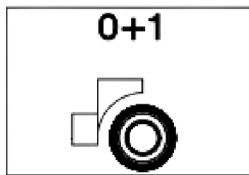

DIN

10,3 [t]	4	
10,0-5,0 [t]	2	
5,0 [t]	1	

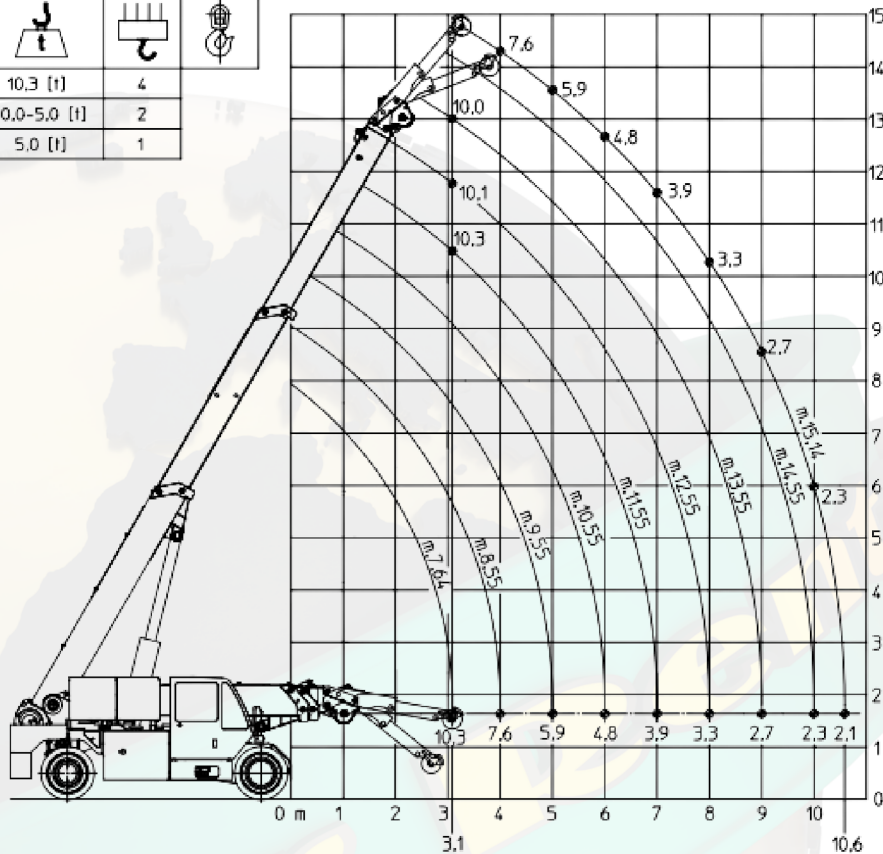

48 km/h	1 km/h	1 km/h



# Gräber

Arbeitsbühnen · Stapler · Krane

WWW.GRAEBER.RENTALS

# ORMIG 40 IE

## INDUSTRIEMOBILKRAN



TRAGLAST MAN.JIB 2,08M (MIT VERL.) - (2 KONTERGEW.)

14000 kg

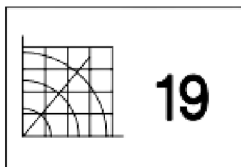
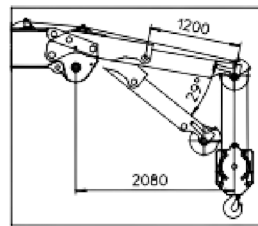
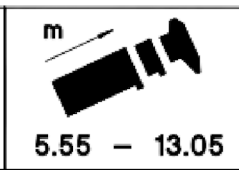
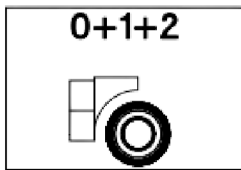

DIN

14,0-10,0 [t]	4	
10,0-5,0 [t]	2	
5,0 [t]	1	

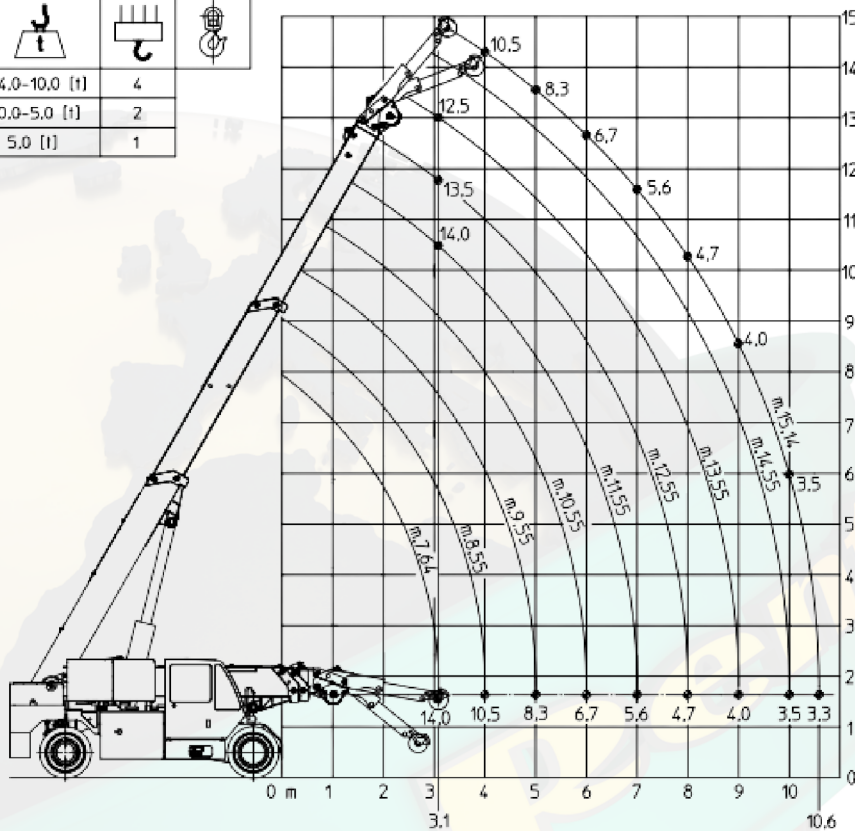

B6	1	1
48 km/h	1 km/h	1 km/h



# Gräber

Arbeitsbühnen · Stapler · Krane

WWW.GRAEBER.RENTALS

# ORMIG 40 IE

## INDUSTRIEMOBILKRAN



TRAGLAST MAN.JIB 2,08M (MIT VERL.) - (3 KONTERGEW.-VOLLER BALLAST)

15000 kg

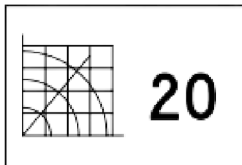
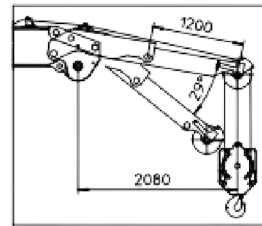
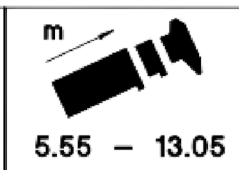
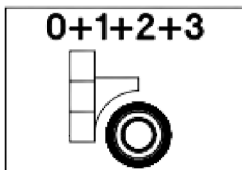

DIN

15,0-10,0 [t]	4	
10,0-5,0 [t]	2	
5,0 [t]	1	

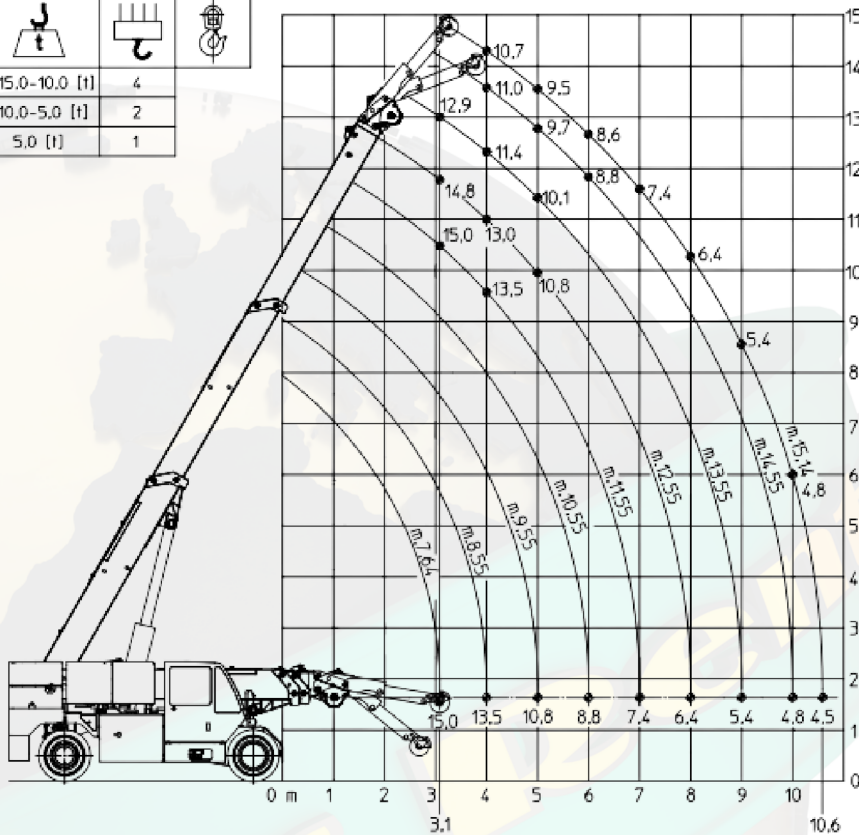

# Gräber

Arbeitsbühnen · Stapler · Krane

WWW.GRAEBER.RENTALS

# ORMIG 40 IE

## INDUSTRIEMOBILKRAN



ANHÄNGEPUNKTE VERHEBEN MIT KRAN (NUR OHNE KONTERGEWICHTE!)

40000 kg

Applicare sui contrappesi n° 2 e 3

7  
8



t2

7  
8



t7

su contrappeso n° 1

t2,6

8

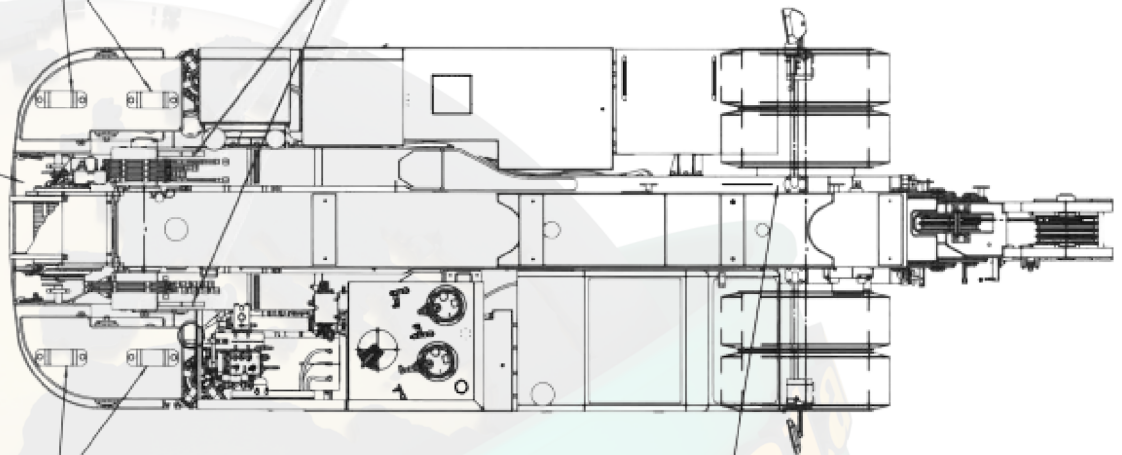

7  
8



t2

Applicare sui contrappesi n° 2 e 3

☆ ZA940E000J0A70100

N° progressivo delle macchine



# Gräber

Arbeitsbühnen · Stapler · Krane

WWW.GRAEBER.RENTALS